

Literature

LEAR – Literature Management

DDBSP - Dortmund Data Bank Software Package



DDBST Software & Separation Technology GmbH

Marie-Curie-Straße 10

D-26129 Oldenburg

Tel.: +49 441 36 18 19 0

Fax: +49 441 36 18 19 10

support@ddbst.com

www.ddbst.com

- 1 Starting LEAR 4
 - 1.1 The Tool Bar 4
 - 1.2 The Menu 5
 - 1.2.1 The File Menu 5
 - 1.2.1.1 New Library 5
 - 1.2.1.2 Open 5
 - 1.2.1.3 Close Library 5
 - 1.2.1.4 Load Data Set Numbers 5
 - 1.2.1.5 Load Data Set Identifiers 6
 - 1.2.1.6 New Dataset 6
 - 1.2.1.7 Import 6
 - 1.2.1.8 Delete Library 6
 - 1.2.1.9 Rename Library 6
 - 1.2.1.10 Extras 6
 - 1.2.1.11 Rebuild Index 6
 - 1.2.1.12 Duplicate Search 6
 - 1.2.1.13 Retrieve Keywords 6
 - 1.2.1.14 Update “Ref” Files 6
 - 1.2.1.15 External Links Settings 7
 - 1.2.1.16 Exit 7
 - 1.2.2 The Edit Menu 7
 - 1.2.2.1 Global Options Page 8
 - 1.2.2.2 Result Window Options Page 9
 - 1.2.2.3 Import Options Page 10
 - 1.2.2.4 Environment Options Page 10
 - 1.2.3 The View Menu 11
 - 1.2.4 The Help Menu 11
- 2 Searching 12
 - 2.1 Quick Search 12
 - 2.2 Advanced Search 13
 - 2.2.1 Search fields 14
 - 2.2.1.1 String Fields 14
 - 2.2.1.2 Number Range Fields 14
 - 2.2.1.3 Date Fields 14
 - 2.2.1.4 Journal Field 14
 - 2.2.1.5 Status 14
 - 2.2.1.6 Links 14
 - 2.2.2 Multiple Queries 14
- 3 Search Results 16
 - 3.1.1 Tool Bar 16
 - 3.1.2 Menus 17
 - 3.1.2.1 Results 17
 - 3.1.2.2 Edit 17
 - 3.1.2.3 Search 17
 - 3.1.2.4 View 18
 - 3.1.2.5 Options 18
 - 3.1.2.6 Windows 18
 - 3.1.3 Grid Functions 19

3.1.3.1	Sorting.....	19
3.1.3.2	Column Moving.....	19
3.1.3.3	Context Menu	19
3.1.3.4	List of Possible Columns	20
4	Journals	21
4.1	Stored Fields.....	21
4.2	Editing	21
4.3	Searching.....	22
4.4	Selecting Journals.....	22
5	Editing Single Sets.....	23
5.1	List of Fields.....	23
5.2	Tool Bar	26
5.3	Special Command Buttons	26
5.4	Font Selection.....	27
5.5	Displaying Externally Linked Files and Folders	27
6	Appendix.....	29
6.1	The Usage of Links	29
6.2	The Data Bank Structure	30
6.3	LEAR Tagged Format	30

1 Starting LEAR

LEAR is the literature management software of DDBSP.

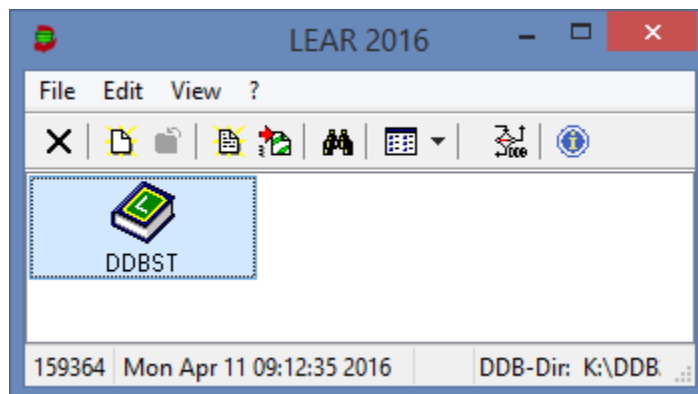

A fresh installed LEAR only contains a single database. It's the “DDBST” database containing all references for the DDBST data banks.

The second database shown here is another “DDBST” database suffixed by a “/p”. This database contains all private references for customer-created data banks. Section The File Menu describes how to create a private literature database.

LEAR handles also other – non-DDBST user-specific databases – they must not have the name “DDBST”.

The status line

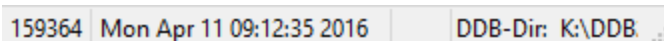







displays the number of available datasets, the data and time of the latest write access of the database under the mouse cursor. In addition always the folder of the Dortmund Data Bank is displayed.

When the mouse cursor is over a database icon the full path to the database file is displayed as hint. This also true when the option “*Display Hints as Popup*” in the “*Global*” part of the options menu is turned off.

1.1 The Tool Bar



The tool bar contains shortcuts to some functions.

-  Create a new and empty literature data bank (library)
-  Close a data bank
-  Append a new and empty data set to a selected library
-  Import another LEAR data bank
-  Search in library or libraries
-  Change display mode of data bank list



Create a private library (only active if there is currently none)



Show About Dialog

1.2 The Menu

1.2.1 The File Menu

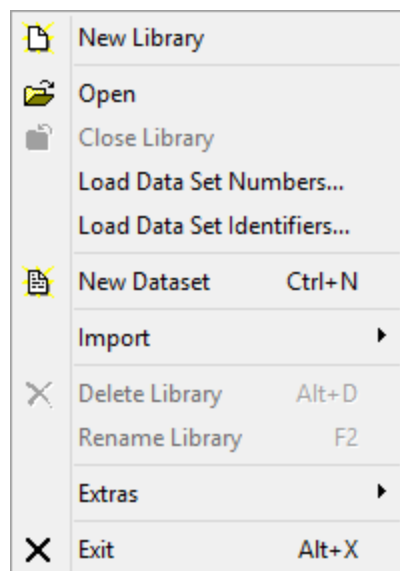

1.2.1.1 *New Library*

“*New Library*” creates a new personal literature database. If the “private DDB” literature database does not exist it can be created using the first option. The second option creates a user specific database which can't be associated with experimental data like VLE.

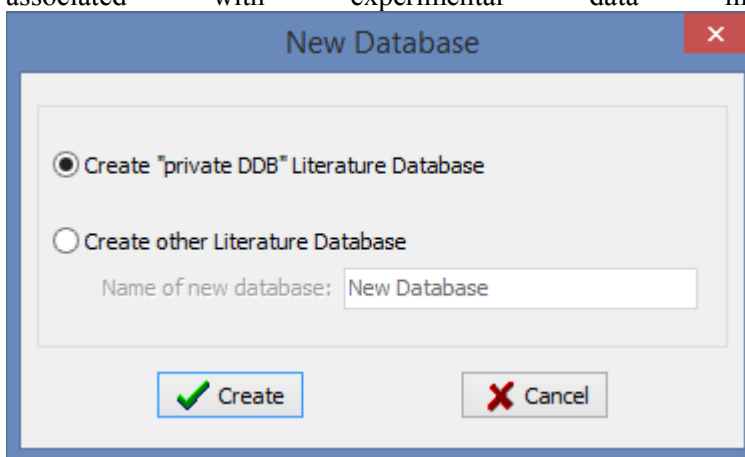

The database is always created in the “LITERAT” sub folder of the private DDB folder.



DDBST



DDBST/p



My New Database/p

This location is indicated by the “/p” suffix for ‘p’rivate folder.

1.2.1.2 *Open*

“*Open*” opens the currently selected data bank and displays the complete list of entries. The same happens when an icon is double-clicked.

1.2.1.3 *Close Library*

“*Close Library*” is closing the database file stream but does not close any open result list. This allows to access the data base file from other tools.

1.2.1.4 *Load Data Set Numbers*

“*Load Data Set Numbers...*” allows loading a file (STX format) that contains dataset numbers. These files can be created in LEAR – representing a search result – or in the main data bank retrieval program (“Dortmund Data Bank”) – containing all references of datasets in a query result.

1.2.1.5 Load Data Set Identifiers

This function is very similar to the previous function but the file to be opened contains additional information about the associated data base of the data set numbers. These files can be created in LEAR and can represent a search result from multiple data banks.

1.2.1.6 New Dataset

“New Dataset” allows entering a new dataset. This is described later in detail.

1.2.1.7 Import

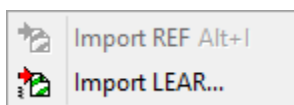

“Import” allows adding data sets from other files and formats.

The “REF” format is an old DDB format which has been superseded by LEAR and “Import LEAR” allows importing other LEAR data banks.

1.2.1.8 Delete Library

“Delete Library” allows removing the selected database files – only the main “DDBST” library cannot be removed. **A removed database cannot be restored.**

1.2.1.9 Rename Library

“Rename Library” allows changing the name of a data bank. The standard DDBST library – both private and public – cannot be renamed.

1.2.1.10 Extras

The “Extras” sub menu contains some utility functions.

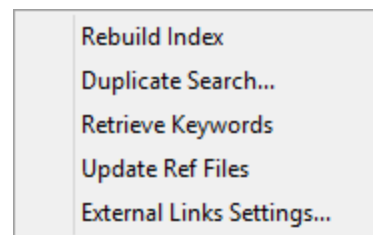

1.2.1.11 Rebuild Index

“Rebuild Index” recreates the LEAR indexes for a faster search. Normally the index is kept up to date automatically.

1.2.1.12 Duplicate Search

“Duplicate Search” allows finding duplicate entries.

The “Duplicate Search Options” dialog allows fine-tuning the criteria. The result of this search is a list with the duplicate entries which can be printed or copied.

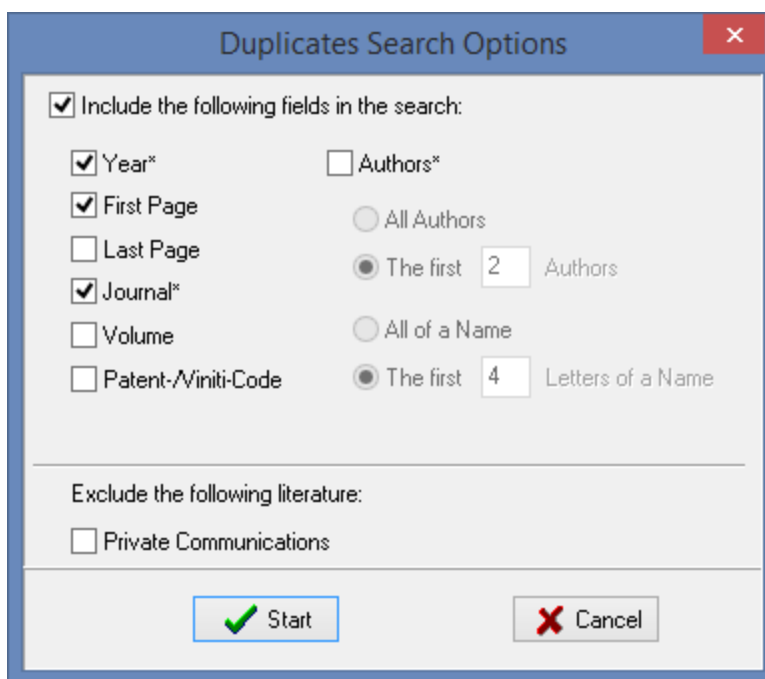

1.2.1.13 Retrieve Keywords

“Retrieve Keywords” : Currently the list of available keywords is stored in the user specific part of the registry. This function adds all used keywords of the selected database to this list.

1.2.1.14 Update “Ref” Files

“Update Ref Files” exports all literature datasets of the selected library to *.ref files of the associated DDB

folder. This function is only available for the DDBST and DDBST/p database. Only datasets with links will be exported.

1.2.1.15 External Links Settings

The external links facility allows connecting scans, data files, PDFs etc. pp. with a reference in the literature database. Use the “External Links Settings” dialog to configure the folders where the associated files reside.

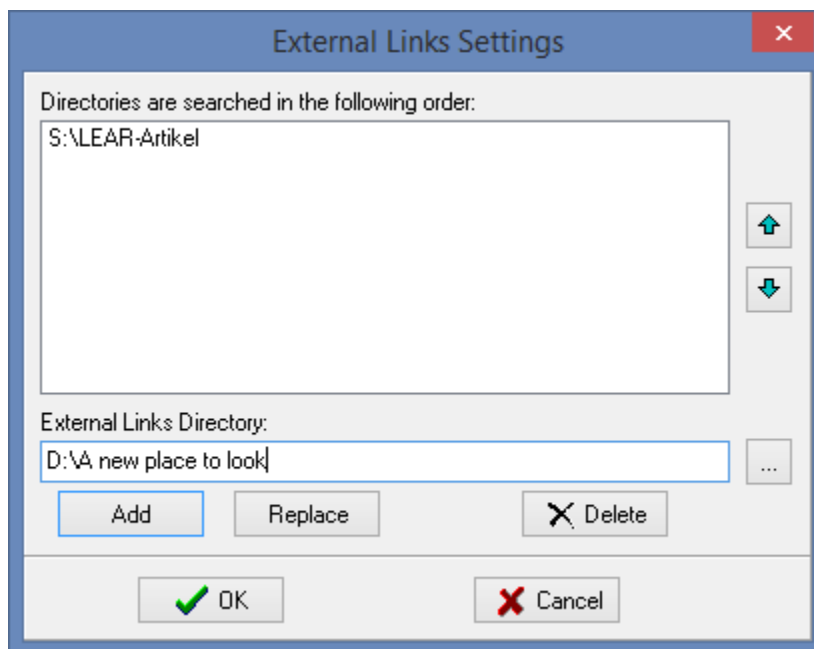

The folders can contain files of any type. The files must start with the associated literature dataset number. A leading “L” is as well allowed as leading zeros. Example: “1234.pdf”, “L1234.pdf”, “001234.pdf” and “L001234.pdf” will all refer to dataset number 1234.

The external link settings are database specific. The usage of external links is described in section Displaying Externally Linked Files and Folders on page 27.

1.2.1.16 Exit

“Exit” closes LEAR and all open result windows.

1.2.2 The Edit Menu

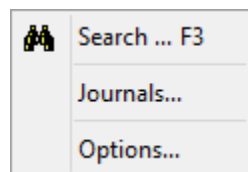

“Search...” opens the search dialog. Searching is described later in detail.

“Journals...” opens the journal list. This dialog is described later in detail.

“Options...” displays the “Global Options” dialog.

1.2.2.1 Global Options Page

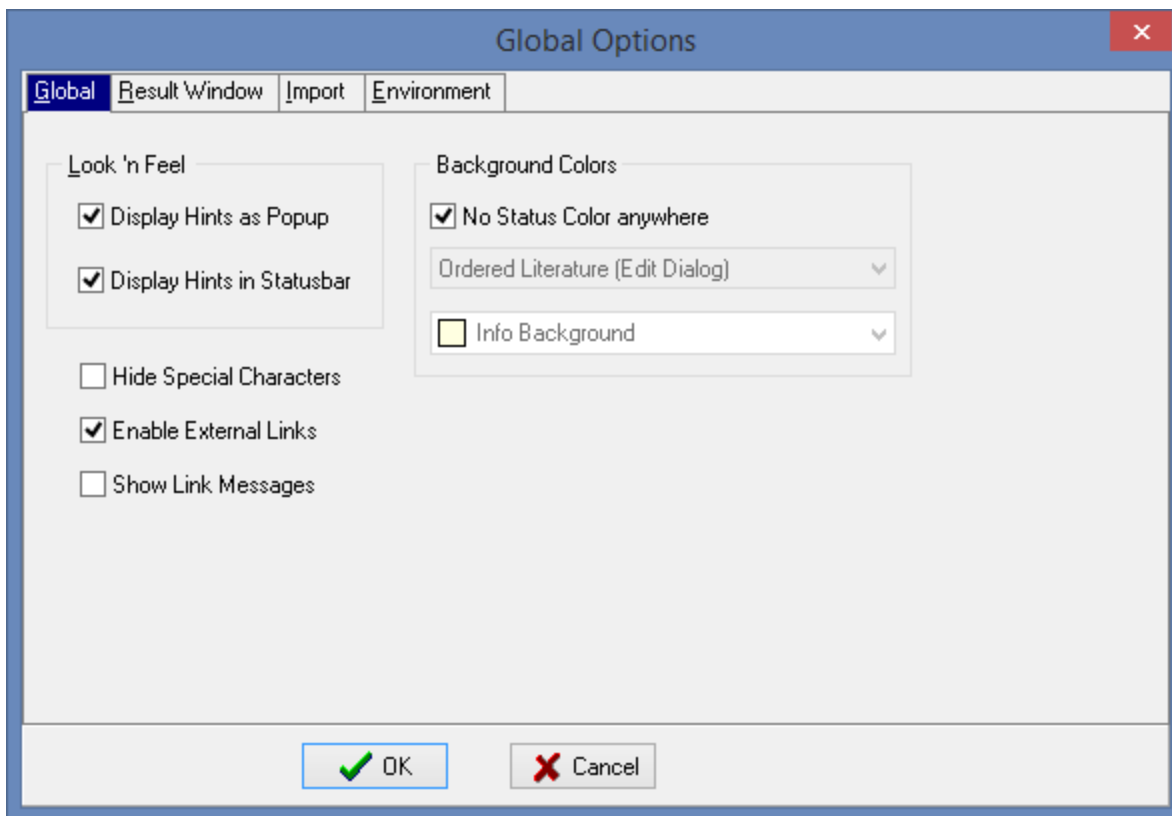

Hints are short descriptions of buttons. LEAR allows displaying these short help strings either as small popup windows at the mouse position or as strings in the status bar at the window bottom.

The color options are for displaying two special literature types.

- Ordered Literature (Edit Dialog)
- Ordered Literature (Result Dialog)
- Exhausted Literature (Edit Dialog)
- Exhausted Literature (Result Dialog)
- Transl. Available Literature (Edit Dialog)
- Transl. Available Literature (Result Dialog)
- To be Deleted Literature (Edit Dialog)
- To be Deleted Literature (Result Dialog)

“Ordered Literature” are articles and books that are in the process of being procured, “Exhausted Literature” are articles and books that cannot be procured, mainly because they are too old (19th century for example). “Translation Available Literature” are articles which are available in another language. This applies mainly for Russian articles where an article translated to English is also stored.

The colors are used as background color either in the single data set edit dialog or in the search result grid.

The “*Enable External Links*” box has to be checked to associate external files to a data set.

1.2.2.2 Result Window Options Page

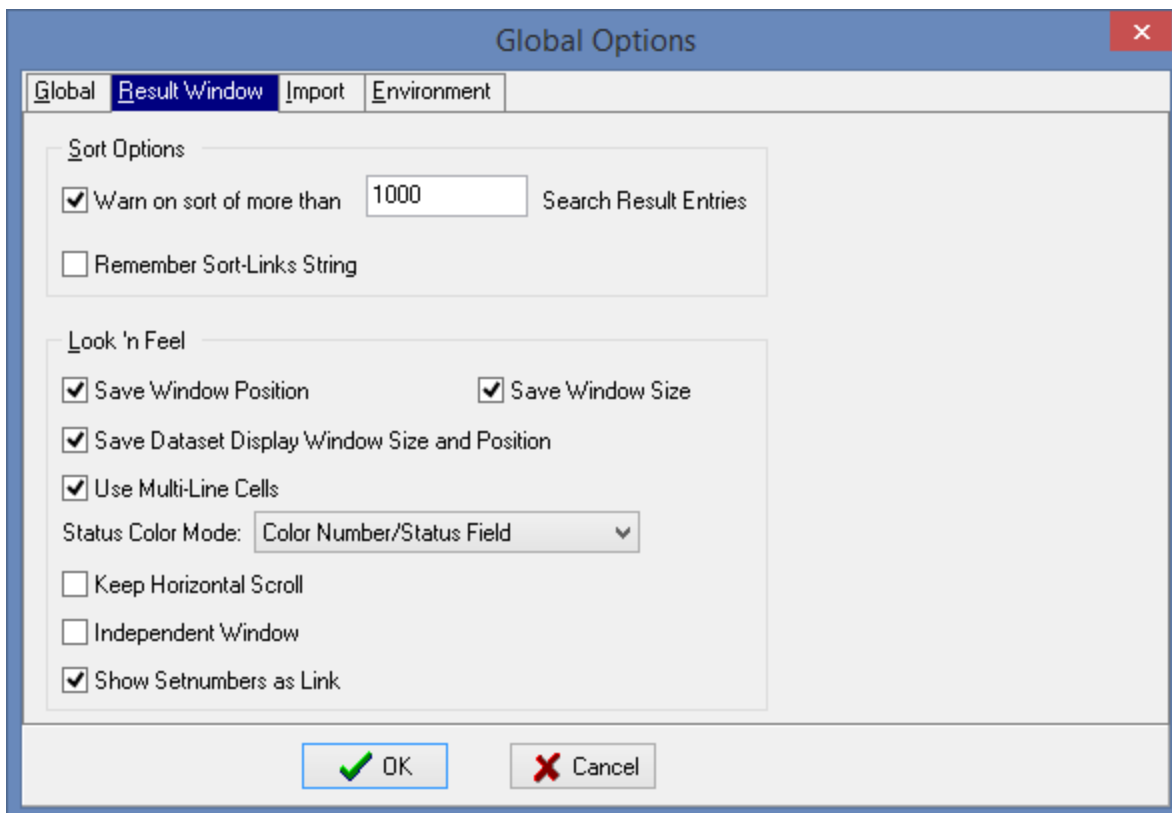

Since sorting of larger search results is rather slow and memory-consuming LEAR allows to display a warning if the search result is larger.

“Remember Sort-Links-String” describes the behavior of sorting a result grid by links.

The options “Save Window Position” and “Save Window Size” are related to the search result window whereas the “Save Dataset Display Window Size and Position” is related to the details window which can be opened in the search result.

With “Use Multi-Line Cells” turned on the cells in the result list expand vertically to fit to the text in the cells. Otherwise all cells have the same high. This is for example useful to see the complete title in the result list.

Multi-Line Cells turned off:

Number	Status	Title	Authors	Date
2	0 - avai...	Excess molar volumes and excess partial m...	Pal A.; Dass G.	19
3	0 - avai...	Partial molar volumes and their temperatur...	Parmar M.L.; Sharma S.	19

Multi-Line Cells turned on:

Number	Status	Title	Authors	Date
2	0 - available	Excess molar volumes and excess partial molar volumes of triethylene glycol monoethyl ether -n-alcohol mixtures at 25°C	Pal A.; Dass G.	19
3	0 - available	Partial molar volumes and their temperature derivatives for some transition metal nitrates in binary aqueous solutions of urea	Parmar M.L.; Sharma S.	19

Data sets which status indicates that the articles are currently not available can be marked with a special color in the result list. Use “Status Color” mode to modify the behavior.

With “*Keep Horizontal Scroll*” is turned on the result list does not jump to the first column when the keyboard is used to navigate through the list. The option can lead to some flickering effects.

Turn “*Independent Window*” on to have all result windows displayed in the Windows status bar. This option will only take effect for windows opened after the option change.

“*Show Setnumbers as Links*” creates links from the data set numbers which allow opening a single set by a single-click.

Number	Title
[19964]	Dimeric Distrib Between Two
[103438]	Multiple-Phas Propane, and

1.2.2.3 Import Options Page

Global Result Window **Import** Environment

Duplicate Check (LEAR/PCP Tagged only)

Include the following fields in the search:

Year* Authors*

First Page All Authors

Last Page The first Authors

Journal* All of a Name

Volume The first Letters of a Name

Patent-/Vinit-Code

Exclude the following literature:

Private Communications

Since LEAR allows importing literature information from multiple sources it is a major task not to import duplicates.

The import options allow fine-tuning the search for duplicates.

1.2.2.4 Environment Options Page

The environment options are only displayed as additional information.

The entries displayed here can be modified in the DDB configuration program.

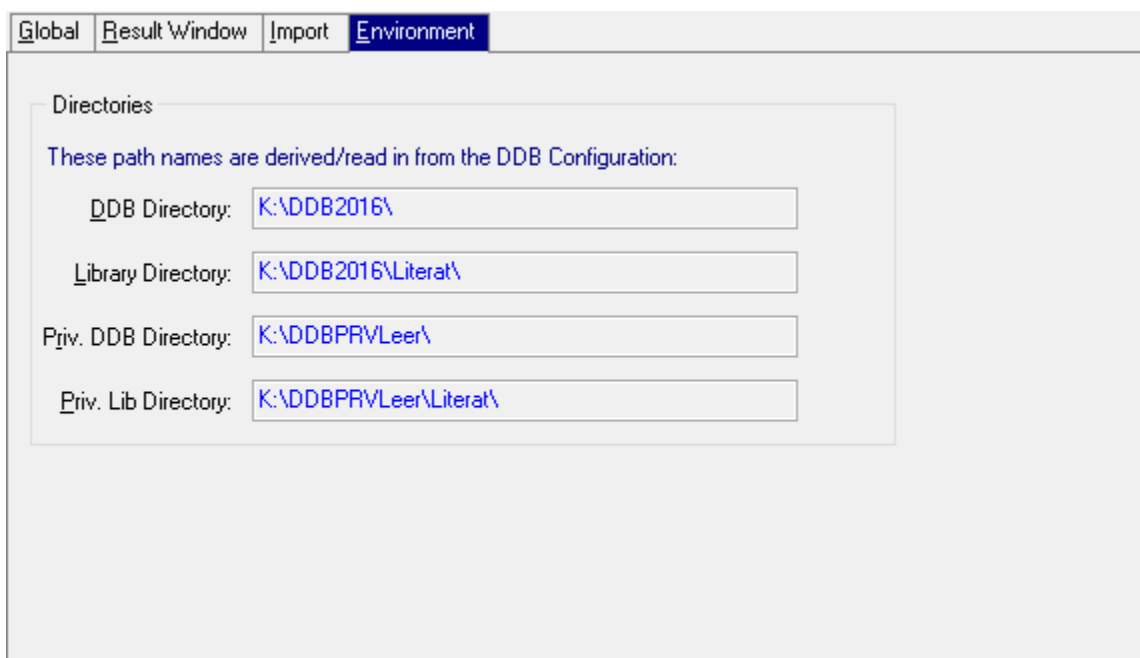

1.2.3 The View Menu

The entries “Normal”, “Small Icons”, “List View”, and “Detailed” change the display of the libraries.

Normal View:

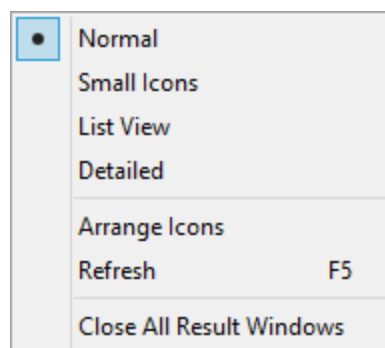

Detailed View:

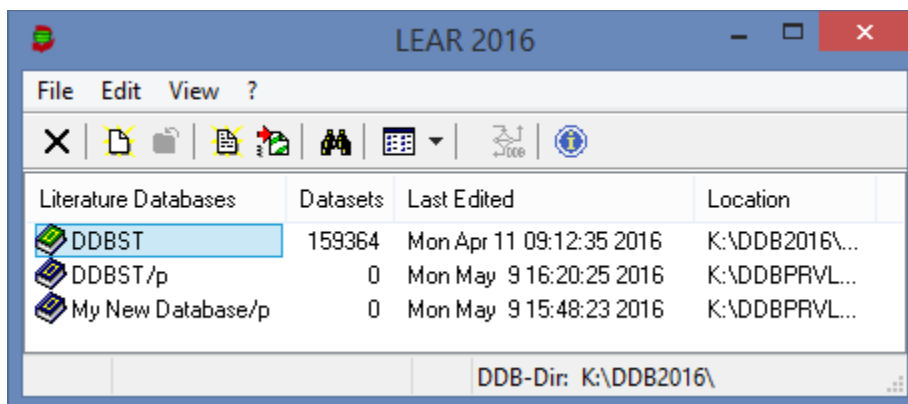

“Arrange Icons” sorts the list of libraries and “Refresh” rebuilds the list.

“Close All Result Windows” closes all result windows.

1.2.4 The Help Menu

“LEAR Help” displays this PDF.

“About LEAR” displays detailed program version information.

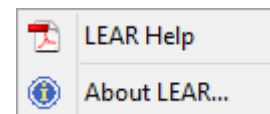

2 Searching

The search can be started from the  button in the main window.

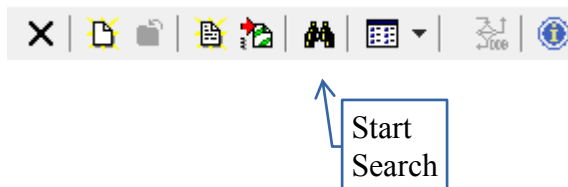

LEAR has implemented two search query modes – one simple and one complex. The simple search query is easier to handle but offers less options. It is possible to start with the simple query and copy the conditions to the complex query to refine the search conditions.

2.1 Quick Search

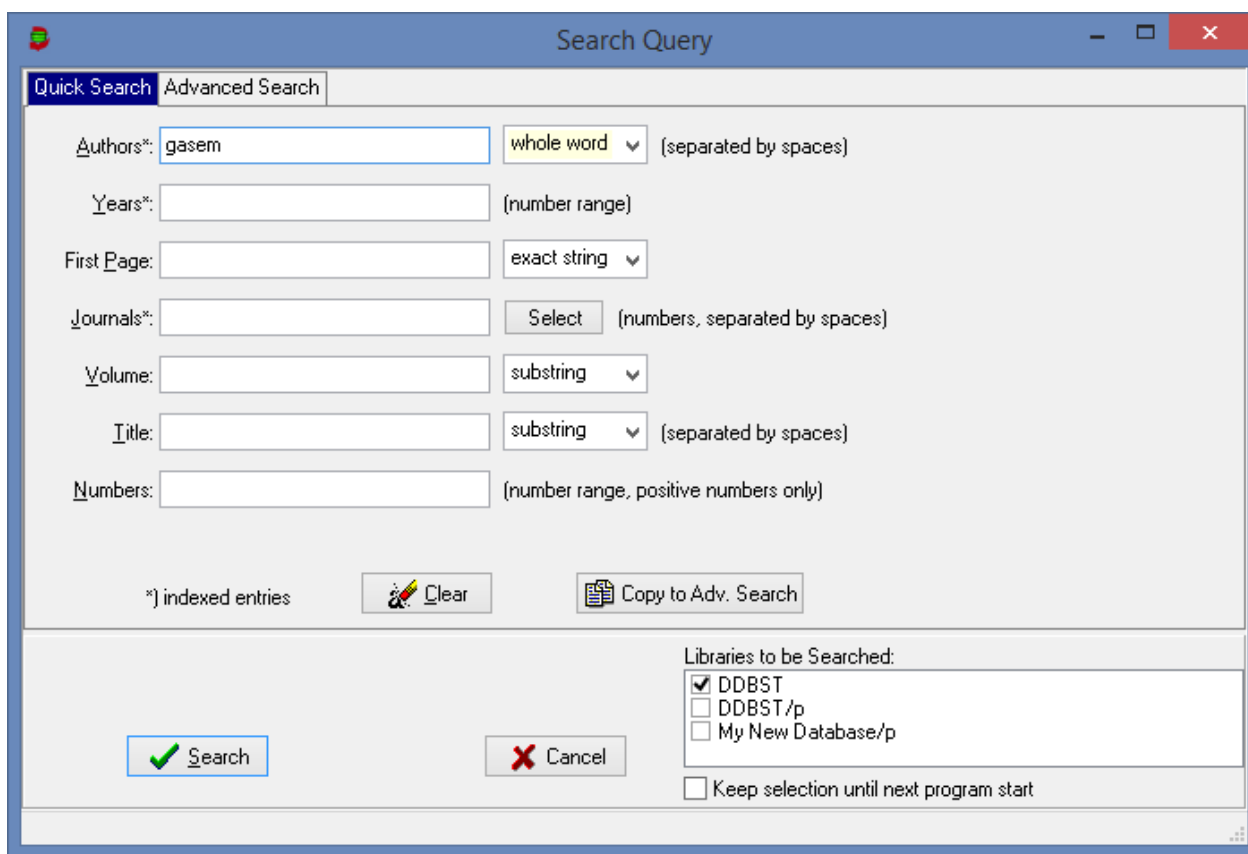

Available Fields are

- Authors** Several names can be entered. The single names have to be separated by spaces. Only references where all names are given will be found (“And” relation). It is possible to specify that the word(s) can match anywhere in the authors list (substring), can only match as full word (whole word). The other options are not very useful and only for completeness.
- Years** A single year or a range of years has to be entered. Any year must be specified with all four digits. A “/” can be used to define a continuous range, use “;” to separate single years. Example: To search for all literature published from 1980 to 1982 or in 1986 use “1980/1982; 1986”.
- First Page** A single number has to be entered. Normally “exact match” is preferred, but it’s also possible to

allow a match as “prefix”, “suffix”, or “substring”.

- Journal A list of numbers denoting the DDB journal numbers separated by blanks can be entered. Use the select button to select journals from the list. See below for details.
- Volume Since volume can contain letters this search allows also a substring search. A search for “12” will also find “123” and “12A”. In addition all options as for “First Page” are possible.
- Title Several words can be entered. The single words have to be separated by spaces. Only titles with all words available will be found (“And” relation). Use “whole word” to find full words only.
- Numbers A range of data set numbers can be specified (format as in “Years”). In most cases this field is not used in combination with the other options. Therefore the field is marked slightly yellow when the content is not empty (to avoid unexpected search failures).

The “*” denotes the fields for which LEAR has indexes. These searches are much faster than non-indexed fields. The author’s index is not an exact index and will be not that efficient (=slower) than other indexes.

The “Clear” button will empty all edit fields. The additional options are not touched.

The “Copy to Adv. Search” button copies the current quick search settings to the advanced search settings. The advanced search page is active afterwards.

The “Libraries to be Search” control contains all available literature databases. Only the selected databases are searched.

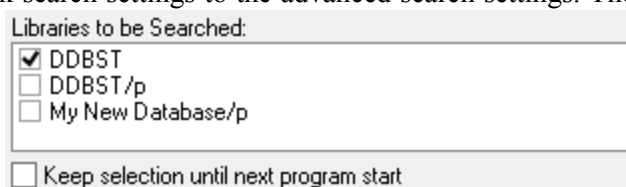

2.2 Advanced Search

The advanced search allows searching in almost all data fields (“Field” column). The “Mode” column contains options specific for the selected data fields. The “Operator” column allows (together the “String Mode” column) to change the behavior of the search. The “Words” column contains the search text or number.

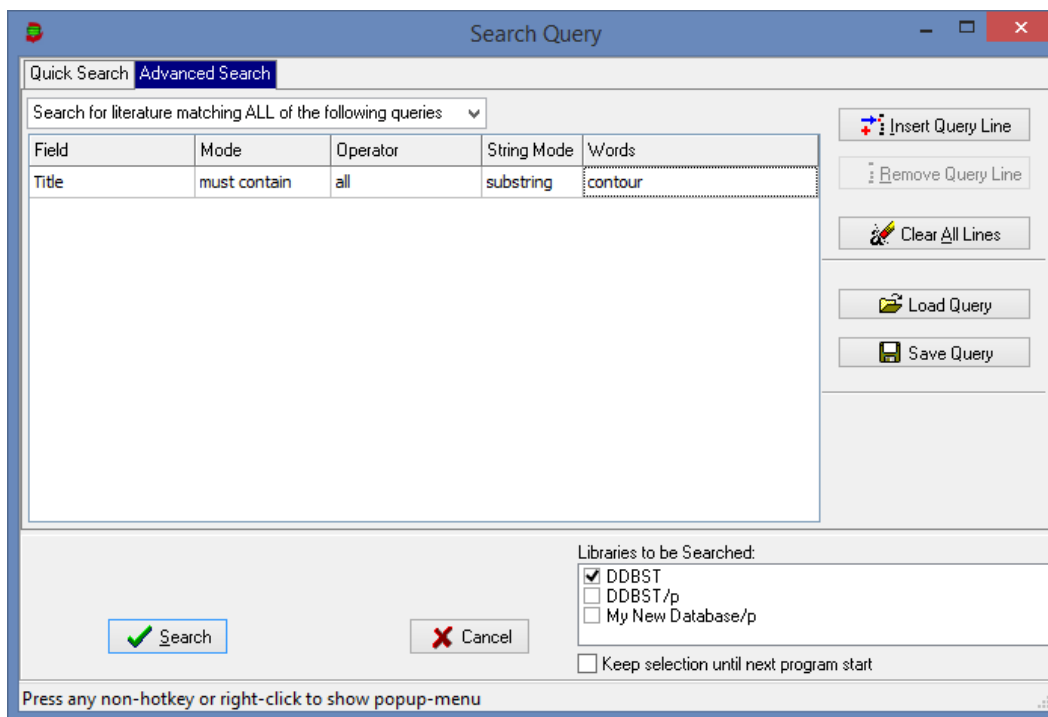

2.2.1 Search fields

Authors
Comment
First Page
Journal
Keywords
Language
Last Page (0)
Lear Number
Links
Location (1)
Place/Inst.
Status
Title
Year
User defined Number
Volume
Issue
Rep./Pat./Vin. No.
First Editor (2)
First Edit Date (3)
Last Edit Date (4)
Last Editor (5)
Series (6)
Book Title (7)
Series Name (8)
Pat. WO No. (9)

2.2.1.1 String Fields

String Fields are “Authors”, “Comment”, “First Page”, “Keywords”, “Language”, “Last Page”, “Location”, “Place/Inst.”, “Title”, “User defined Number”, “Volume”, “Issue”, “Report/Patent No.”, “First Editor”, “Last Editor”, “Series”, “Book Title”, “Series Name”.

For *String Fields* the mode column has two options: “must contain” or “must not contain” and the operator column allows to search for “all” or “any” words in the words column. In addition it is possible to specify if a text must match as “substring”, “whole word”, “prefix”, “suffix” or “exact string”. The “Words” column accepts words separated by blanks. To search for text containing blanks enclose them in quotation marks.

2.2.1.2 Number Range Fields

Number Range Fields are “LEAR Number” and “Year”. It is possible to specify either one number and search for all which “is equal”, “is lower or equal” or “is greater or equal” or you can specify a number range (see quick search dialog for details).

2.2.1.3 Date Fields

Date Fields are “First Edit Date” and “Last Edit Date”. The “Words” column only accepts one valid date. Click on day, month, or year to change it. A click on the down arrow brings up a date selection dialog. It is possible to search for dates which are “equal”, “lower or equal” or “greater or equal”.

2.2.1.4 Journal Field

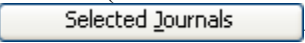
It is possible to search for (“must contain”) or exclude (must not contain) datasets from a list of journals. Use the button  to view/edit the selected journals. See section “*Selecting journals*” on page 22 for details.

2.2.1.5 Status

The status of an article can be “available”, “missing”, “to be ordered”, “urgent demand”, “in process”, “can't be procured”, “not ordered” or “check needed”. The word column presents a pop up menu with the possible entries.

2.2.1.6 Links

Links are simple numbers and data bank dependent (separate numbers for VLE, ACT, ...). The mode column contains the data banks list (from “aae” to “vle”) and the operator column allows to set the options “equal”, “lower or equal”, and “greater of equal”. The words column allows entering a single number.

2.2.2 Multiple Queries

The advanced search dialog allows entering multiple search queries.

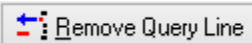
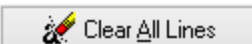

Field	Mode	Operator	String Mode	Words
Title	must contain	all	substring	contour
Year	of publication	is greater or equal		2000

-  adds a new line,
-  removes a line,
-  clears all query lines but leaves an empty initialized line (prepared for “Authors” search).

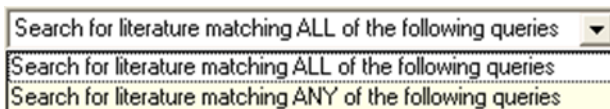
Queries can be combined.

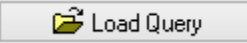

- Either ALL query conditions must be fulfilled, or
- ANY (one) query condition must be fulfilled, other conditions can be fulfilled.

Use  to load and  to save a query. Queries are saved as INI files in a user specific folder.

 A click on the “Search” button will bring up the search result window (see next section). If nothing could be found the following dialog comes up:

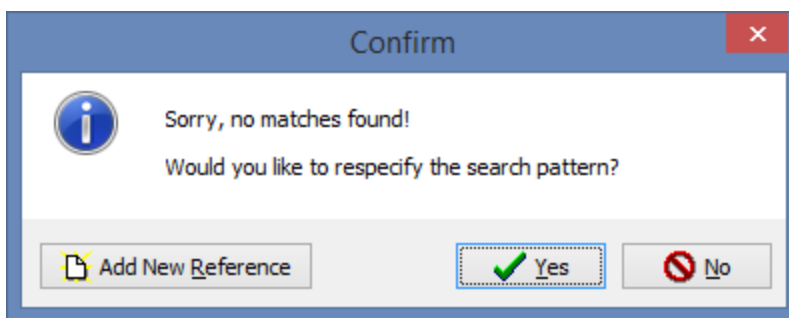

Click “Yes” to bring up the search query dialog again to refine the search option. It is also possible to add a new reference from this dialog.

3 Search Results

After performing a search a query result window with all matches is displayed.

Number	Title	Authors	Publicati	Pages	Links	Volume	Issue	External Files	Journal	Library
[1]	Determination of Activity Coefficients in Gas Chromatographic Systems in the Presence of Mixed Retention Mechanisms: Alkanols (C3-C5) at Infinite Dilution in Squalane and in n-Octadecane	Romero L.M.; Figueira M.R.; Gagliardi L.G.; Nardillo A.M.; Castells R.C.	1999	3351 - 3355	act[522]; hpv[4412]	1		None	Article in Journal	DDBST
[2]	Excess Molar Volumes and Excess Partial Molar Volumes of Triethylene Glycol Monoethyl Ether -N-Alcohol Mixtures at 25°C	Pal A.; Dass G.	1999	237 - 246	pcp[21926]; ve[1942]	28	3	None	Article in Journal	DDBST
[3]	Partial Molar Volumes and their Temperature Derivatives for some Transition Metal Nitrates in Binary Aqueous Solutions of Urea	Parmar M.L.; Sharma S.	1998	718 - 722			37	None	Article in Journal	DDBST
[4]	Excess partial molar enthalpy of 1-propanol in 1-propanol-NaCl-H2O at 25°C: The effect of NaCl on molecular organization of H2O	Matsuo H.; To E.C.H.; Wong D.C.Y.; Sawamura S.; Taniguchi Y.; Koga Y.	1999	2981 - 2983			103	None	Article in Journal	DDBST
[5]	Measurement and Correlation of Excess Molar Enthalpies for (Ethenediol, or 1,2-Propanediol, or 1,2-Butenediol + Water) at the Temperatures (285.65, 298.15, 308.15, 323.15, and 338.15) K	Kracht C.; Ulbig P.; Schulz S.	1999	1113 - 1127	he[2300]		31	None	Article in Journal	DDBST
[6]	Volumes of Aqueous Alcohols, Ethers, and Ketones to T=523 K and P=78 MPa	Schulte M.D.; Shock E.L.; Obsil M.; Mater V.	1999	1195 - 1229			31	None	Article in Journal	DDBST

Datasets: 159364

3.1.1 Tool Bar



Close the search result window.



Close this and all other search result windows.



Copy marked sets to the Windows clipboard in a publication format.



Start email program (MAPI) with a new mail and the selected datasets as text file attachment (more than one entry selected) respective as text in mail body (one dataset selected). The default format is the publication format. To send the datasets in the display format click on the down arrow to get the

menu item.



Open a search query window. **A search started from this place will perform a search in the given sub list.** To search the full database either the full list must be active or switch back to the main window and start the search from there.

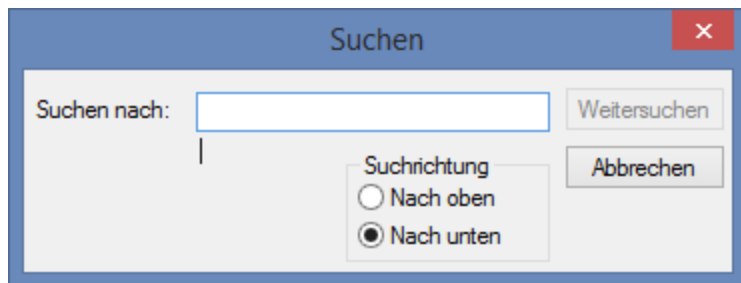

This search doesn't read the data bank but only the grid content.

The search result is not a new query result but the first grid line where the search item has been found will be selected.



Search for a data set number within this result list.



This function starts a search in the main data bank retrieval program for datasets of the marked references.



This function brings the main LEAR window to front.



This function shows the list of available external files for the marked data sets.

3.1.2 Menus

3.1.2.1 Results

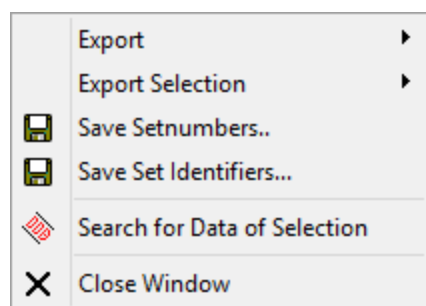

“Export” allows saving the grid content either as comma-separated files or as an Excel- and OpenOffice-compatible XLS files.

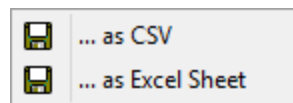

“Export Selection” allows exporting the marked datasets either as a tagged text file or as a LEAR library. If an existing LEAR library is selected, the marked sets will be appended.

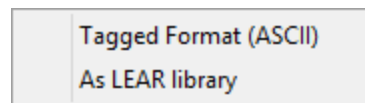

“Save Setnumbers...” allows storing the LEAR dataset numbers only. Private references are stored as negative numbers. “Save Set Identifiers” stores the data set numbers together with their data base identification.

See above for a description of “Search for Data of Selection” and “Close Window”.

3.1.2.2 Edit

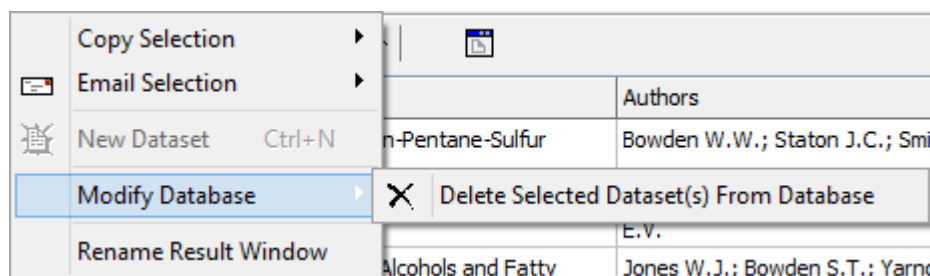

“Copy Selection” allows copying the marked lines either in a publication format for use in text processor or in a grid format for use in spread sheets.

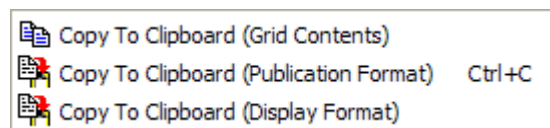

“Email Selection” allows sending the marked datasets either in publication or display format (see above).

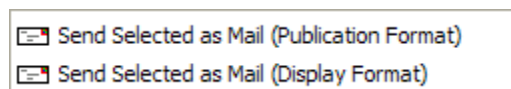

“New Dataset” opens the edit dialog and allows entering a new data set. This option is only available if the full list is active.

“Modify Database” and “Delete Selected Datasets” allows removing data sets from the database. **This command actually deletes the data sets in the database. It is not recoverable.** Only references that are not used in the DDB can be removed.

Use “Rename Result Window” to give the result list a meaningful name. It is not possible to have two windows with the same name. Only the text between the brackets in the window title will change. Renaming the window makes it easier to identify a specific search result when switching between them using the “Windows” menu entry or the task bar entries (“Independent Window” turned on).

3.1.2.3 Search

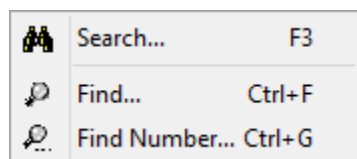

The search functions have been explained in the tool bar section.

3.1.2.4 View

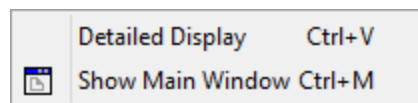

“Detailed Display” opens a child window with a detailed text view of the currently selected reference. The contents updates automatically when a different dataset is selected.

The text in the “Dataset Display” window can be printed and copied. It is possible to turn word wrap on an off and to set the window always on top.

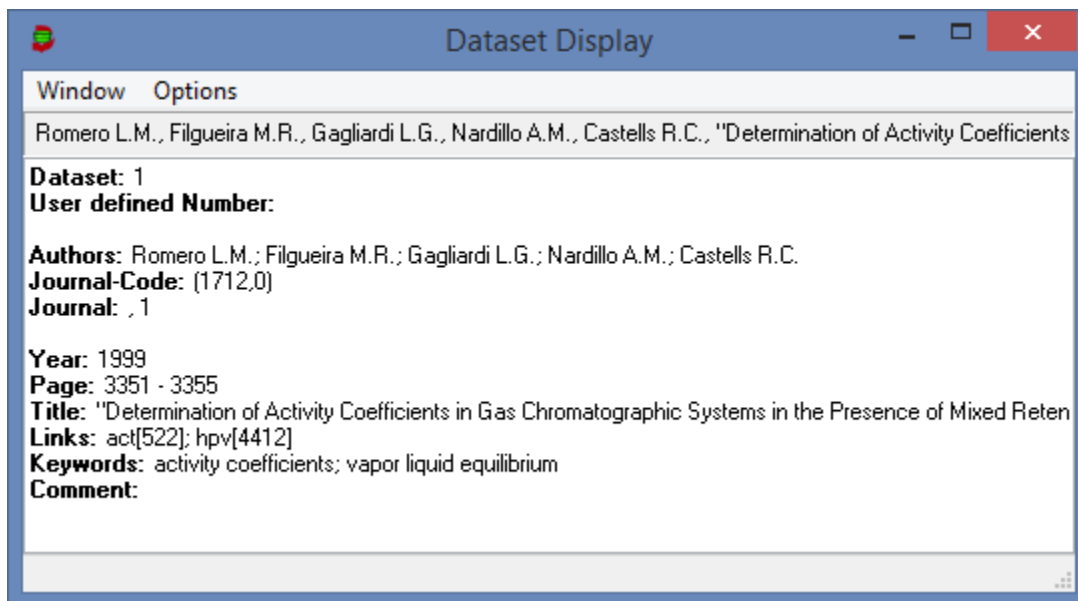

3.1.2.5 Options

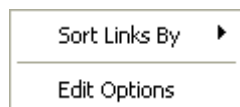

“Sort Links By” allows selecting the sort mode if the datasets shall be sorted by the database links. Normal mode is simple sorting by alphabetical order. Since a reference might contain multiple links a reference with “aae[34];vle[34]” will be sorted by the “aae” entry.

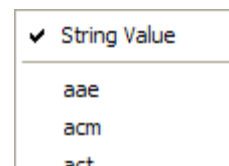

The “vle” link will not be used because it is on second place. This can be prohibited by choosing the “vle” link as basic sort criterion.

“Edit Options” displays the “Result Window” page of the global options dialog.

3.1.2.6 Windows

The “Windows” menu can be used to switch between several search results. This is useful if “Independent Window” is turned off.

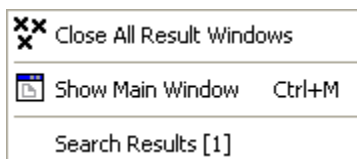

3.1.3 Grid Functions

3.1.3.1 *Sorting*

The grid allows opening an edit window for single set by double-clicking its line. Editing single sets is described in details elsewhere.

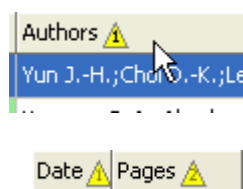

The grid allows sorting its content by clicking in the first row.

A second click on the same column reverts the sort order.

Shift-click allows to sort by more than one criterion, like sort first by date and second by pages.

3.1.3.2 *Column Moving*



It is possible to change the order of the columns. This is done by clicking on the heading of a column, holding down the left mouse button while moving the mouse cursor along the heading to the left or to the right.

3.1.3.3 *Context Menu*

The context menu of the grid repeats several of the functions of the tool bar and the menu. The following functions are unique.

 Change Color of Column 'Title'...

“*Change Color of ...*” allows to select another background color for a column.

 Hide Column 'Title'

A column can be removed from the result list. The only column that can't be removed is the “*Number*” column.

 Insert Column

▶ Use “*Insert column*” to insert a hidden column into the result list. The column will be inserted *before* the column below the mouse cursor.

Remove Selection

“*Remove Selection*” allows removing datasets from the search result list. This does *not* modify the database.

 Create New Window from Selection

“*Create New Window from Selection*” opens a new search result window with only the selected sets.

Common Properties...

“*Common Properties*” opens an edit window which allows to edit common properties of the selected data sets.

These “common” properties have to be the same in all selected datasets before editing; the different entries are inactive and cannot be changed. The only exceptions are “Keywords” and “Comment”. If the entries are different it is possible to choose to “append” a value to all selected datasets or to “replace” the value in all selected data sets by the specified value. “None” will leave the entries unchanged. **The changes here modify the database.**

3.1.3.4 List of Possible Columns

- | <ol style="list-style-type: none"> 1. Number: Internal data set number 2. Title 3. Authors 4. Publication Year 5. Pages: First and last page separated by a hyphen 6. First Page 7. Last Page 8. Links: Data base specific reference numbers 9. Volume 10. Issue 11. Journal 12. Library: Name of the LEAR data bank | <ol style="list-style-type: none"> 13. External Files: Hyperlinks to external files if available 14. ISSN: International Standard Serial Number 15. CAS code of Journal 16. Journal Number: Internal DDB number of journal 17. Keywords 18. Language 19. Place | <table border="1" style="border-collapse: collapse; width: 100%;"> <thead> <tr style="background-color: #e0e0e0;"> <th style="padding: 2px;">External Files</th> </tr> </thead> <tbody> <tr> <td style="padding: 2px;">[.pdf;.pdf;.pdf;.pdf]</td> </tr> <tr> <td style="padding: 2px;">[.pdf;.pdf;.pdf;Folder]</td> </tr> </tbody> </table> | External Files | [.pdf;.pdf;.pdf;.pdf] | [.pdf;.pdf;.pdf;Folder] |
|--|---|---|----------------|---------------------------------------|---|
| External Files | | | | | |
| [.pdf;.pdf;.pdf;.pdf] | | | | | |
| [.pdf;.pdf;.pdf;Folder] | | | | | |

4 Journals

The journal's editor can be started from the “Edit” menu of LEAR's main window.

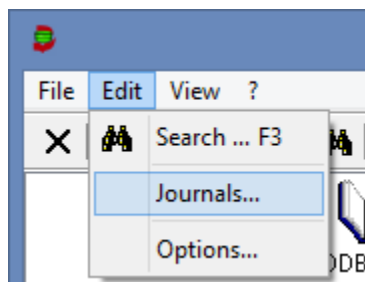

LEAR uses an underlying journals list and provides an editor for this list.

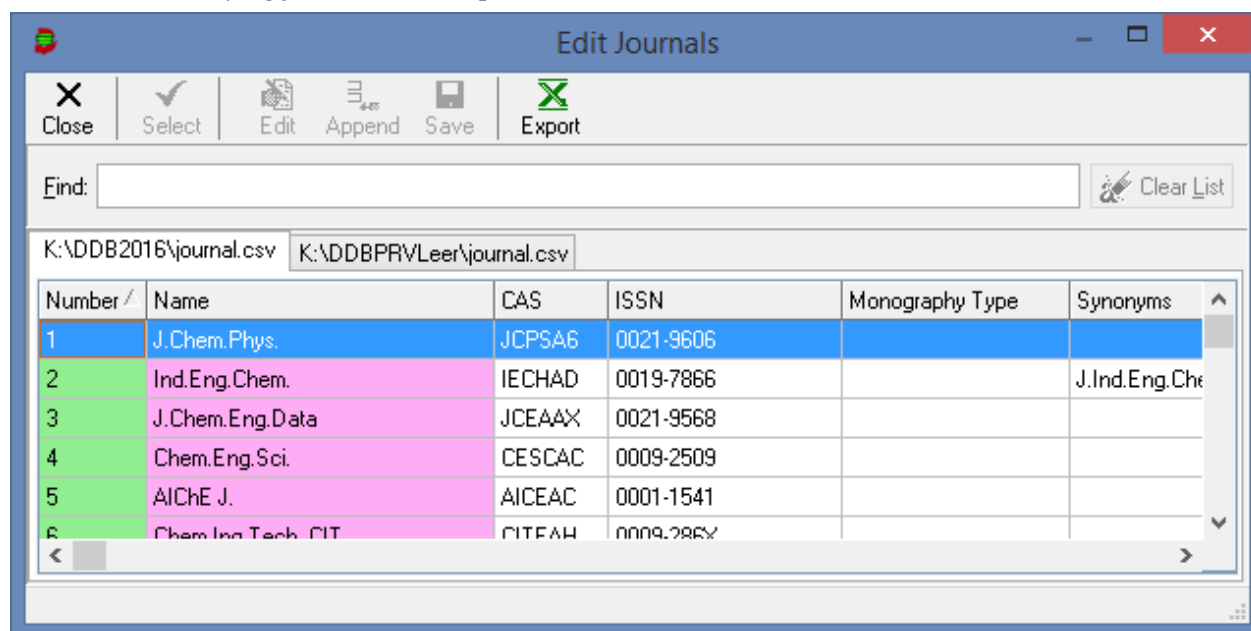

4.1 Stored Fields

The most important fields in the journal list are

- a journal number
- a journal short name
- the CAS source index
- the ISSN number
- a description of the type if the reference is not a journal.

4.2 Editing

The single entries are editable after selecting the “Edit” button.

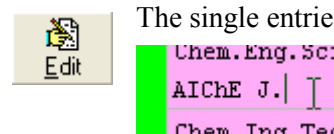

The “*Monograph Type*” can be easily changed by choosing one item from the drop-down list. An empty field means “Journal”.

 Changed entries are marked red until they have been saved using the “Save” button.

5	AICHE J.	AICEAC	715=Zing730jcZA7770;89=ZA3801
---	----------	--------	-------------------------------

 “Append” allows adding new journals.

2457	Zh. Eksp. i teor. fiz. / Pis'ma
2458	Theor. i primeneniye nepodvizhnoi fazy v GZhKhrom., Ki
2459	

An empty row is appended to the journals grid and the grid is automatically in edit mode. By pressing the “Save” button the new journal can be used in the literature data bank.

 The entire content of the journal’s list can be export to an Excel (*.xls) file.

4.3 Searching

Searching for journals allows combining queries by simple logical operations.

Search String	Result
eng&chem	All journals containing “eng” <i>and</i> “chem” are listed.
eng chem	All journals containing <i>either</i> “eng” <i>or</i> “chem” are listed.
eng&chem&!trans	All journals containing “eng” <i>and</i> “chem” but not “trans” are listed.

Searching is always restricted to the currently listed journals. To search all journals the entire list can be made visible again by pressing the “Clear List” button.

4.4 Selecting Journals

The journals dialog is in selection mode when it is called from a search query window.

Field	Mode	Operator	String Mode	Words
Journal	must contain	any of the 2		<input type="button" value="Selected Journals"/>

In this case the dialog hides the “Edit” and “Append” buttons and activates the “Select” button.



To select a single journal mark the grid line and press the “Select” button. It is also possible to select all marked journals by selecting one of the drop-down menu entries.

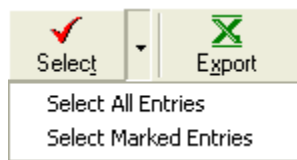

5 Editing Single Sets

The editor for single sets can be called by either

1. double-clicking a line or
2. single-clicking on the data set number hyperlink in a search result or by
3. adding a new dataset from the main window.

The screenshot shows the 'Edit Entry 1 [DDBST]' window with the following fields and values:

- Literature Kind: Article in Journal
- Dataset Number: 1
- User defined Number: (empty)
- Title: Determination of Activity Coefficients in Gas Chromatographic Systems in the Presence of Mixed Retention Mechanisms: Alkanols (C3-C5) at Infinite Dilution in Squalane and in n-Octadecane
- Authors: Romero L.M., Figueira M.R., Gagliardi L.G., Nardillo A.M., Castells R.C.
- Pages: 3351 to 3355
- Volume: 1
- Issue: (empty)
- Series: (empty)
- Year: (empty) to 1999
- Journal: 1712 Phys.Chem.Chem.Phys. (PCCP)
- ISSN: 1463-9076
- Publisher/Place: (empty)
- Language: (empty)
- Keywords: activity coefficients; vapor liquid equilibrium;
- Comments: (empty)
- URLs: 1 (with Open, Del, New buttons)
- DOI: (empty)
- Links: act[522]; hpv[4412];

Buttons at the bottom: Save, Close

5.1 List of Fields

The list of fields changes with the type of paper (monograph, article, etc.). In the following the most important fields are described.

- Literature Kind Defines the type of paper stored.

Article in Journal	<p>The drop-down box shows the complete list of possible entries. Changing to another type changes the dialog controls, because the different types need their special descriptions.</p> <p>A list of these special controls is given in the following list.</p>
Book	
Thesis	
Article in Conference	
Report	
Patent	
Private Communication	
Deposited Document	
Unpublished	
Not specified	

- Precise Kind

Literature Kind: Precise Kind:

For some kind of literature a more precise description is needed. This detail's list contains a list of a more precise description of the reference kind. These lists are not complete and always contain an entry which can be used if nothing else matches (e. g. "monograph" for books).

- Dataset Number A unique number specifying the data set. This number is automatically created by the program and cannot be altered.
- User defined Number This is a freely definable number useful when another literature list has been imported in a LEAR library. It allows keeping the original numbering.
- Title The title of the paper.
- Authors The authors of the article. Each author has his or her own cell and the naming convention (for DDBST) data banks are family name followed by space and initials. The initials are not separated by blanks.

The order of the authors can be changed by dragging the title bar to a different location.



	Delete current cell
	Merge with Left Cell
	Merge with Right Cell
	Insert Column Left
	Insert Column Right
	Check Authors

The context menu allows deleting a cell, merging two cells or inserting a cell.

Press the 'Return' key in the last cell to append a new cell.

A check function for authors is also available (see below).

- Pages First page and last page of an article are stored in different fields. In case of an article from a book the first and last page should be used to denote the important pages.
- Year Normally articles have only one year whereas data collections may have been published over a period. If there's only one year given, this year should be entered in the 'to' field.
- Institution/Place For theses and similar papers: A text field for further information on the authors, their

institute or company.

- Viniti Code For deposited documents:

Viniti Code:

A “Viniti” is a specifically Russian and Ukrainian document type. It was and is common practice in the USSR and its successors that articles have been published only with their title and abstract. The rest of the paper with the experimental data is available from central libraries near Moscow and Kiev.

- Patent No. Patent number, only used for patents.
- WO No. Patent number, granted by the World Intellectual Property Organization, or WIPO.
- Report Number Report number, only used for reports.

- Journal

The journal list is a separate file. LEAR only stores a number which is an index to the journal in the journals file.

The journal can either be selected using the button next to the journal name, by double-clicking in one of the grayed journal fields or by simply typing in the journal number left from the journal name. The journal selection dialog is described in section “*Selecting Journals*” on page 22.



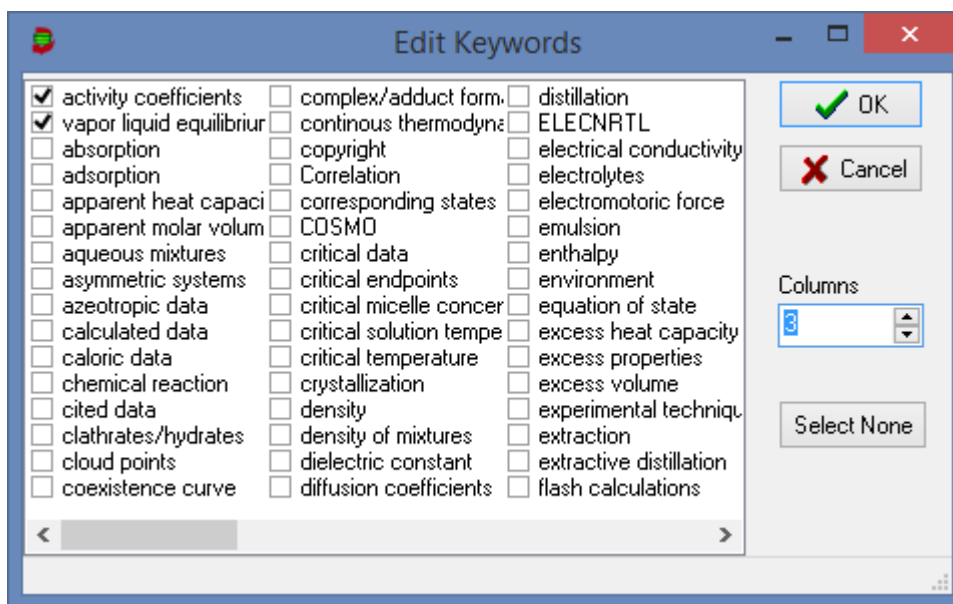



- ISSN International standard series number of a journal. This field belongs to the journal entry and can only be modified in the journal editor.
- Volume Volume number of an article
- Issue Issue number of an article
- Series Series number or letter of an article
- Book Title In article from a book “Title” contains the title of the article. “Book Title” can then contain the title for the whole book.
- ISBN International standard book number (for books only)
- Edition Edition of a book
- Editor Editor of a book
- Publisher / Place Name of the publisher (for book) or the place (for conference and thesis)
- Language The original language of the paper (Chinese, Japanese, German, etc.)
- Keywords LEAR manages keywords not as pure text, but as special list. This decision has been made for getting keywords organized.



The list contains also short terms for the different DDB data banks.

- Entering Date Date of incorporation. This field is filled automatically and cannot be altered.
- Location A text field for defining the location of the paper.
- Comments This is a place for unstructured additional information.

5.2 Tool Bar

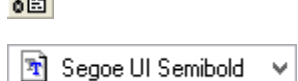
-  Close the edit dialog
-  Copy dialog content to the clipboard (tagged format)
-  Paste dialog content from the clipboard (tagged format)
-  Copy dialog content to the Windows clipboard – either in publication format or in display format
-  Print dialog content
-  Start main data bank retrieval program and display all datasets from current reference.
-  Show external links (see below for details)
-  Font selection (see below)

5.3 Special Command Buttons

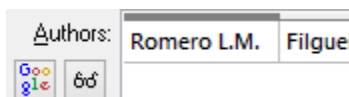

The eyeglasses button besides the authors allows checking the author's names order. The Google button starts a search in the registered web browser.

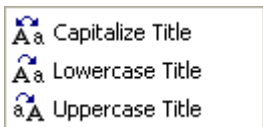
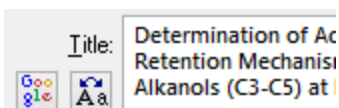

The  button calls a simple function for converting the title in uppercase/lowercase text. This function is far from perfect.

Right-click the button to get a menu that allows also converting all to uppercase or all to lowercase.

5.4 Font Selection

The single set editor allows changing the font of the dialog's controls.

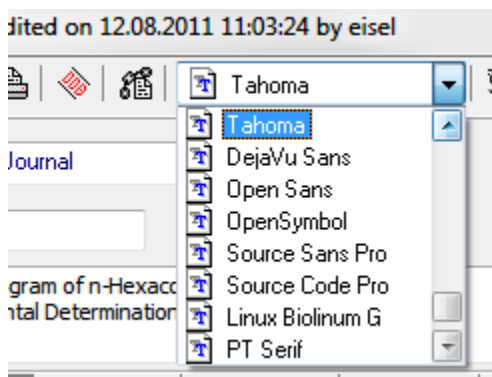

Here's an example where the font is changed from Lucida Console

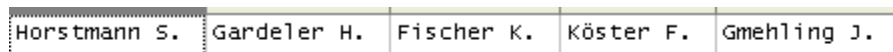

to Arial.



5.5 Displaying Externally Linked Files and Folders

The external links facility allows connecting scans, data files, PDFs etc. with a reference in the literature database. The dialog which displays the linked files and folders can be directly displayed



from within the single dataset editor. If the connection symbol  is enabled there are files associated with the current dataset.

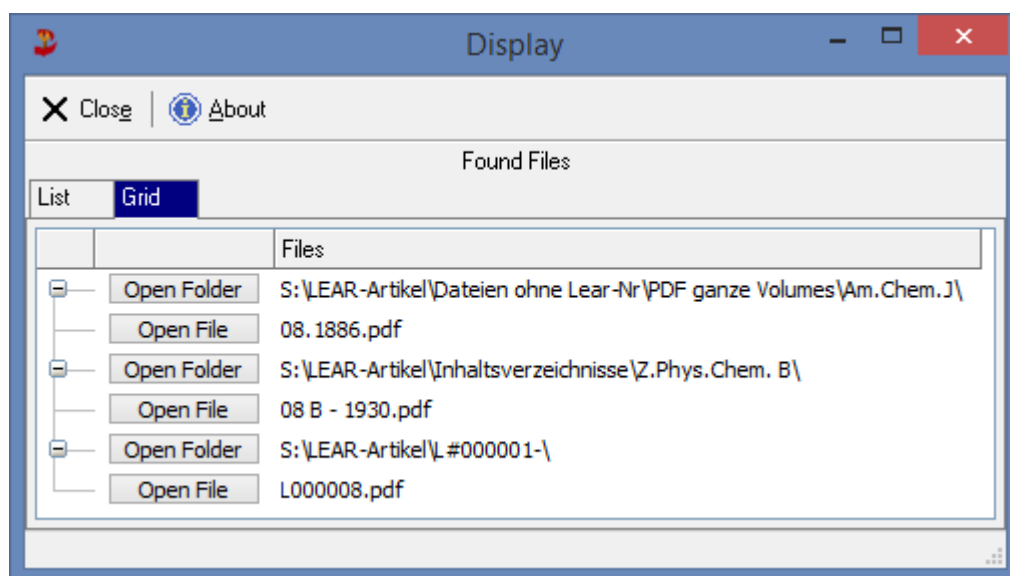

The link display dialog displays the linked files and folders. Double-click on a file name or click “Open File” to load the document into the registered application. Double-click on a folder name (or a click on “Open Folder”) to see the full folder contents.

Section “*External links settings*” on page 7 describes how to configure the folders for external files.

6 Appendix

6.1 The Usage of Links

The motivation for creating the Dortmund Data Bank was to collect experimental data for the development of several models. This led to the conclusion that only originally published values are useful to have in the data bank and that led to the conclusion that the data sets have to be referenced.

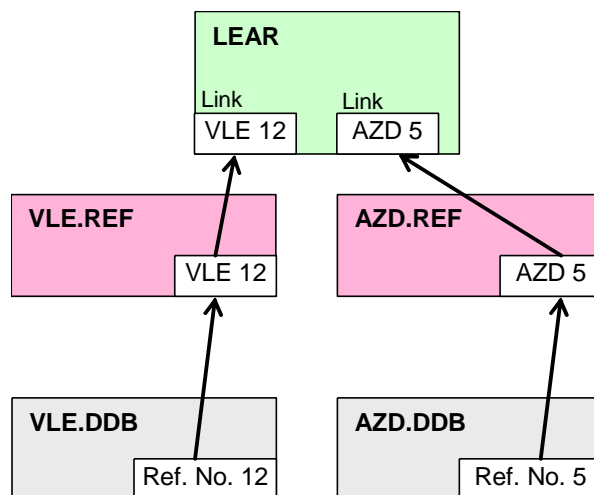

In earlier days these references have been stored in separate lists for every data bank. This caused problems in adding references (multiple copies of a single paper had to be stored if a single paper contained data for different data banks) and searching (several files had to be searched).

To overcome these problems a new and unified literature management has been introduced called LEAR (Literature Excerpt, Archiving and Retrieval). All single reference lists are still existent because the data banks still have their own numbering system (ranging from one up to their respective highest available number) but the references are now in one list and the old numbers are included in this list (see Figure 1).

The new management makes it easier to find references, no duplicates are introduced anymore and there's only a single place for editing and adding reference information.

6.2 The Data Bank Structure

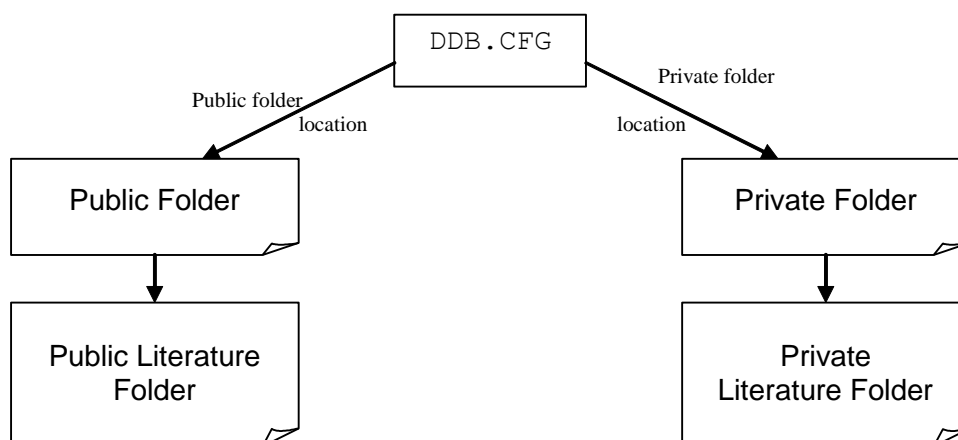

LEAR has been designed to support multiple libraries; two of these libraries have special meanings. The DDB system supports two data banks, a public and private data bank. These are normally located in two different folders. LEAR uses this organization and supports a private and a public literature data bank.

A private data bank is intended for use by our customers to store company owned data and literature. The public data bank is distributed by DDBST GmbH.

6.3 LEAR Tagged Format

The tagged format (ASCII) is used for example when a single dataset is copied to the clipboard. The defined tags are:

Tag	Meaning
SET:	Data set number
CLA:	List of links in the format DDB-short-term (HE for mixing enthalpies in the example) followed by the link number in square brackets. If there are more links each are separated by blanks.
AUT:	Authors
TIT:	Title
DCL:	Journal class
JRC:	Journal number (from the DDB journals list)
JRN:	Journal short name
JCS:	Journal code (CAS source index)
JLT:	Journal long name
LNG:	Language
PNR:	Patent number
YEA:	Year

Tag	Meaning
PGE:	First and last page separated by blank
VOL:	Volume
SER:	Series
ISS:	Issue
PLC:	Place
BTI:	Book title
EDI:	Edition
ISB:	ISBN
SNA:	Series name
ENA:	Editor name
CMT:	Comment
UDN:	User defined number
KWD:	Keywords
EDA:	First edit date
CRE:	First editor
LOC:	Internal location
STA:	Status
LDA:	Last edit date
LED:	Last editor
DOI:	Document object identifier or web link
VER:	Format version
PWO:	Patent WO number